



SmartMod+ Analogue Input Module HE379THM100 4 channel mV and Thermocouple



1 Specifications

	Min	Max		
Input type			Thermal Drift – Full Scale	±0.005 %/ °C
Voltage 50 mV 100 mV 250 mV	-50mV	+50mV	Thermal Drift CJC	±0.02 %/ °C
	-100mV	+100mV	Sample Time (per channel)	0.5 / 1 sec
	-250mV	+250mV	Input Impedance	>= 1 MΩ
			CJC Compensation	± 1 °C
Thermo-couple J K R S B E T N	-210°C	+1200°C	Storage Temp.	-40° to 85° C
	-210°C	+1372°C	Operating Temp.	-10° to 60° C
	-50°C	+1767°C	Relative Humidity	0 to 90% Non-condensing
	-50°C	+1767°C	Mounting	DIN Rail standard EN-50022
	+400°C	+1825°C	Line Resistance	< 0.8 μV/Ω
	-210°C	+1000°C	Weight	200g
	-210°C	+400°C	Communications	Modbus/RTU RS-485 half duplex
	-210°C	+1300°C	Max Data Transmission Baud Rate	115.2 Kbps
Input Accuracy	±0.05 % f.s. Or 5 μV		Max. Distance	1.2 Km
Linearity	mV ±0.1 % f.s TC ±0.2 % f.s		CE Compliance	Immunity EN 61000-6-2 Emission EN61000-6-4
External Power Supply Voltage	10-30Vdc			
Required Power (Steady State)	35mA @ 24Vdc 45mA @ 10Vdc			
Reverse Polarity Protection	60 V dc max			
Isolation	1500 V ac, 50Hz, 1 min			

Mechanical Dimensions (mm)

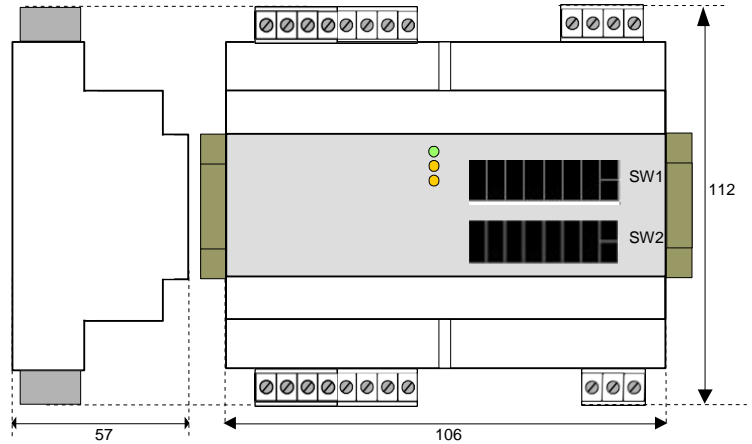

Note: Number of I/O terminal connections varies from model to model

Connections

ANALOGUE INPUTS

VOLTAGE

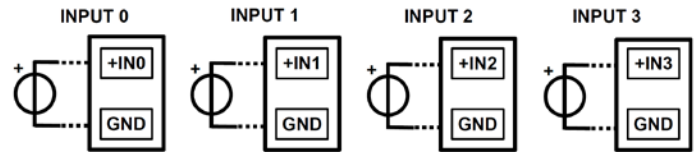

THERMOCOUPLES

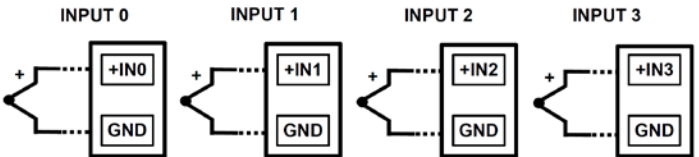

NOTE: The inputs are not isolated channel to channel (terminal GND is common)

2 Wiring – I/O

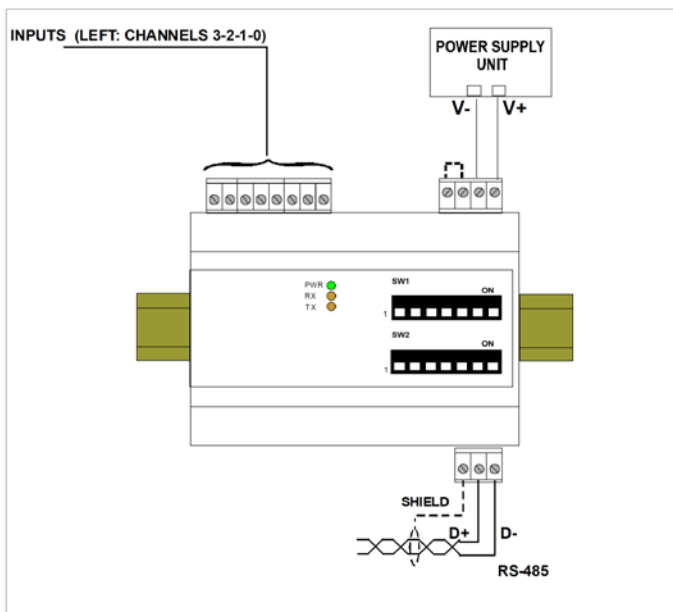

Serial Line RS485

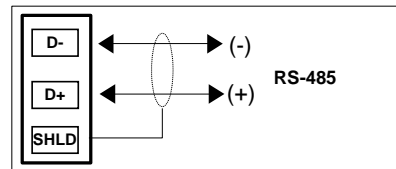

POWER SUPPLY

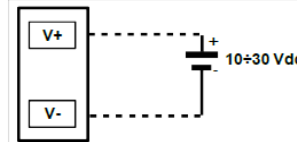

INIT

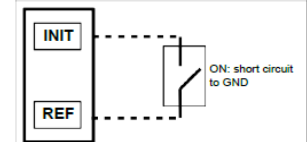

3 DIP Switches: Table of Configuration

Warning: Set all the dip-switches to the OFF position to access the module in EEPROM mode (the module will follow all the communication parameters set by the software) or INIT.

Power-cycle the module to apply the settings of the dip-switches.

Tab 1: Mode Settings (Pos.1)

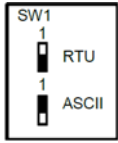

TAB.3 Baud rate settings (Pos.4 LSB; Pos.6 MSB)

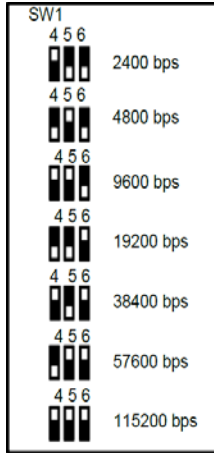

TAB.2. Parity settings (Pos.2 LSB; Pos.3 MSB)

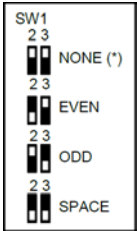

Note (*)
 -in Modbus RTU mode the setting is NONE, number of bits = 8
 -in Modbus ASCII mode the setting is MARK, number of bits = 7

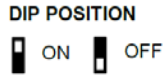

4 Communication Protocols

This module is designed to work with the MODBUS RTU/MODBUS ASCII protocol, the standard protocol in fieldbus, and allows the direct interface of HE379 series modules to all Horner X-Series controllers.

5 User Instructions

Before installing this module, please read the **Installation Instructions** section carefully. It is possible to configure the module using the dip-switches located on the front of the module using the INIT mode. Connect the terminal INIT to the terminal REF and, at power-on, the module will be automatically set to the configuration set-up. Connect the power supply, serial bus and analogue inputs as shown in the **Wiring** section. The LEDs state depends on the working condition of the module, see the **LED Indicator** section to verify the modules working state. To perform configuration and calibration operations, read the instructions below.

To simplify handling or replacing the module, it is possible to remove the wired terminals when the module is powered on.

6 Installation Instructions

Attach the HE379THM100 to DIN rails in the vertical position. For optimum operation follow these instructions:

When the modules are installed side by side and - If the panel temperature exceeds 45°C and power supply voltage is 10 VDC - **it may be necessary to separate them by >5 mm:**

Make sure that there is sufficient air flow around the module, avoid placing near cable routing or other objects that can obstruct the ventilation slits. Additionally, avoid mounting modules above appliances that generate heat. Ideally, they should be placed in the lower part of the panel. Install the module in a location without vibration.

It is also recommended to avoid routing conductors near power signal cables (motors, induction ovens, inverters etc...) and to use shielded cables for connecting signals.

7 LED Indicator

LED	COLOUR	STATE	DESCRIPTION
POWER	Green	ON	Device Powered
		OFF	Device Not Powered
		BLINK	1 sec. - Watch-Dog alarm condition occurred
RX	Orange	BLINK	Receiving Data
		OFF	Not receiving data
TX	Orange	BLINK	Transmitting Data
		OFF	Not Transmitting data

The LED's are located on the front of the model.

8 User Guide- MODBUS Protocol

All of the data shared by modules communicating via Modbus RTU / Modbus ASCII protocol are mapped in tables at defined addresses. Each data point can be one of two types:

- "REGISTER", 2 bytes (word of 16 bits) that can be associated with analogue input or output, variables, set-point, etc...
- "COIL", 1 single bit that can be associated with digital input or output or to a logic state.

A register can contain the image (mirror) of more coils; for example, each of the 16 digital inputs of a module can be read or written as a single bit by addressing the coil related to each input. Alternatively, the 16 bits can be read or written as a single word addressing the associated register where each bit corresponds to a coil.

In the Modbus protocol, registers and coils are divided as per the following groups of addresses:

- 0xxxx and 1xxxx = Coils (bit)
- 3xxxx and 4xxxx = Registers (word)

When read and write functions are performed, use the tables indicated below to address the registers and coils.

9 Supported Modbus Function Codes

Function	Description
01	Read Coil Status (0xxxx)
02	Read Inputs Status (1xxxx)
03	Read Holding Registers (4xxxx)
04	Read Inputs Registers (3xxxx)
05	Force Single Coil
06	Pre-set Single Register
15 (0F)	Force Multiple Coil
16 (10)	Pre-set Multiple Registers

10 Coil Table

COILS TABLE

(*)Coil (Hex)	(*)Coil (Dec)	Description	Access
0x0001	00001	Open Detect #0	RO
0x0002	00002	Open Detect #1	RO
0x0003	00003	Open Detect #2	RO
0x0004	00004	Open Detect #3	RO
0x0009	00009	Watchdog Enable	R/W
0x000A	00010	Watchdog Event	R/W
0x000B	00011	Power Up Event	R/W

NOTES:

(*) Subtract 1 from the address position number of the register and/or coil. Registers and coils marked as RO in the column 'Access' are Read only registers. Registers and coils marked as R/W in the column 'Access' are Read and Write registers. For HE379 series modules, the group of data 0xxxx is the mirror of the group 1xxxx, the group of data 3xxxx is the mirror of the group 4xxxx, therefore the first register can be addressed as either 30001 (with function code 04) or 40001 (with function code 03).

11 Register Table

Register Position (*)	Description	Access
40001	Test	R/W
40002	Firmware [0]	RO
40003	Firmware [1]	RO
40004	Name [0]	R/W
40005	Name [1]	R/W
40006	Communication	R/W
40007	Address	R/W
40008	Delay RX/TX	R/W
40009	WatchDog timer	R/W
40010	System Flags	R/W
40011	Input type Channel Enabling	R/W
40013	Offset CJC	R/W
40014	Measure CJC	RO
40015	Input # 0	RO
40016	Input # 1	RO
40017	Input # 2	RO
40018	Input # 3	RO
40023	Sync Input value # 0	RO
40024	Sync Input value # 1	RO
40025	Sync Input value # 2	RO
40026	Sync Input value # 3	RO
40031	Input Offset # 0	R/W
40032	Input Offset # 1	R/W
40033	Input Offset # 2	R/W
40034	Input Offset # 3	R/W
40039	Real Zero of Input # 0	R/W
40040	Real Span of Input # 0	R/W
40041	Scaled Physical Zero # 0	R/W
40042	Scaled Physical Span # 0	R/W
40043	Real Zero of Input # 1	R/W
40044	Real Span of Input # 1	R/W
40045	Scaled Physical Zero # 1	R/W
40046	Scaled Physical Span # 1	R/W
40047	Real Zero of Input # 2	R/W
40048	Real Span of Input # 2	R/W
40049	Scaled Physical Zero # 2	R/W
40050	Scaled Physical Span # 2	R/W
40051	Real Zero of Input # 3	R/W
40052	Real Span of Input # 3	R/W
40053	Scaled Physical Zero # 3	R/W
40054	Scaled Physical Span # 3	R/W

Mode	M
MODBUS ASCII	0
MODBUS RTU	1

Baud Rate	B2	B1	B0
2400	0	0	1
4800	0	1	0
9600	0	1	1
19200	1	0	0
38400	1	0	1
57600	1	1	0
115200	1	1	1

Parity RTU	Parity ASCII	P1	P0
None	Mark	0	0
Even	Even	0	1
Odd	Odd	1	0
Space	Space	1	1

No. bit	N
7 bit	0
8 bit	1

NOTE:

-the number of bits is ignored, in ASCII mode is fixed to 7; in RTU mode is fixed to 8.

40007: ADDRESS

Contains the MODBUS address of the module, the values allowed are from 1 to 247 decimal. Each node connected to the same line must have a unique address. The address 255 is used for broadcast function.

-Default value: 01

40008: DELAY RX/TX

Indicates the value of the delay time between the reception of a query and the transmission of the response, expressed as milliseconds.

-Default value: 01(1 ms)

40009: WATCHDOG TIMER

Contains the value of Watchdog timer, expressed in intervals of 0.5 seconds. If the Watchdog is enabled and the module doesn't receive a command for the time set in this register, the Watchdog Alarm will be activated (refer to section "Procedures").

-Default value: 10 (5 sec.)

40010: SYSTEM FLAGS

Contains the enable bits and system events of the module. The following parameters are configurable:

WATCHDOG ENABLE

Enables the Watchdog alarm. If the alarm is enabled and the module doesn't receive commands for a time higher than the one specified in register 40009, the Watchdog Alarm will be activated (refer to section "Procedures").

0 = Watchdog disabled.

1 = Watchdog enabled.

WATCHDOG EVENT

Indicates the state of the Watchdog Alarm. If the alarm is enabled and the module doesn't receive commands for a time higher than the one specified in register 40009, this bit is forced to 1. To erase the alarm set this bit to 0. If the bit is forced to 1 by a command of the Master unit, a Watchdog event will be simulated and consequently an alarm condition will be created.

0 = Normal condition

1 = Alarm condition

POWER-UP EVENT

This bit is forced to 1 each time the module is powered-on in order to indicate that the module has been switched-off or a reset has occurred. By setting this bit to 0 and checking its state it is possible to monitor if a reset of the module has occurred.

0 = reset not occurred

1 = reset occurred

COIL 00001-00004: OPEN DETECT

When a sensor connected to a channel has a broken connection (ruptured sensor, cables not connected or over-temperature), the coil associated with that channel is forced to 1.

It is possible to use this register to read and write at the same time all the bits without implementing the specific functions of read and write of coils (01-02-05-15)

Bit	15	14	13	12	11	10	9	8	7	6	5	4	3	2	1	0
Set	-	-	-	-	4	3	2	1	-	-	-	-	-	11	10	9

12 Description Modbus Registers

40001: TEST

This register is used for the following function:

-Synchronized Sampling (refer to section "Procedures")

40002 / 40003: FIRMWARE

Field of 2 read only registers; contains the firmware identifier provided by the manufacturer.

40004 / 40005: NAME

Field of 2 read/write registers (4 bytes or 4 ASCII characters) available for the user, it can contain the name of the module or an abbreviation that identifies its function inside the plant. Each one of the 4 bytes can be written by values from 0 to 255, ASCII characters included.

The default value of this field contains the identifier of the module expressed in ASCII characters.

-Default value: "7501" (ASCII).

40006: COMMUNICATION

If the user wants to set the communication parameters, it is necessary to set the bits of this register referring to the table below in order to configure baud-rate, parity and mode. The configuration of the parameters is not necessary if it is done by the dip switches.

-Default of manufacturer: 38400 bps, mode RTU, parity NONE

Bit	15	14	13	12	11	10	9	8	7	6	5	4	3	2	1	0
Desc.	-	-	-	-	-	-	-	-	-	M	P1	P0	N	B2	B1	B0

40011/40012: INPUT TYPE / CHANNEL ENABLING

Contains the configuration of the sensor type connected to each input. The input channel can be configured independently; it is recommended to disable the channels not used.

The numeric code associated with each input type is made of 4 bits as indicated in the table below:

- Default value: 09 (Tc K)

Insert the configuration values (as group of 4 bits) in the register as indicated in the table below:

Bit	40011
15-12	Input Type #3
11-8	Input Type #2
7-4	Input Type #1
3-0	Input Type #0

Value	Type
00h	Disabled
01h	± 50 mV
02h	± 100 mV
03h	± 250 mV
08h	Tc J
09h	Tc K
0Ah	Tc T
0Bh	Tc E
0Ch	Tc R
0Dh	Tc S
0Eh	Tc B
0Fh	Tc N

NOTE: The channels can be configured independently, with the exception of ±100mV and ±250mV, for these input types all of the channels must have the same configuration.

40013: OFFSET CJC

Calibration value of the CJC offset of the thermocouples. The value is expressed as 0.01 °C, signed.

40014: MEASURE CJC

Shows the temperature of CJC of the thermocouples (temperature of the terminal). The value is expressed as 0.01 °C.

Register	Type
40015	INPUT # 0
40016	INPUT # 1
40017	INPUT # 2
40018	INPUT # 3

Type	Decimals
± 50 mV	2
± 100 mV	2
± 250 mV	2
Thermocouples	1

These registers contain the value of each channel converted to engineering units.

The values are expressed as 0.01 mV (for voltage inputs) or 0.1 °C (for Thermocouple inputs). The numeric format is 16 bit signed integer; the number of decimals depends on the input type as indicated in the table above.

Register	Type
40023	SYNC INPUT VALUE # 0
40024	SYNC INPUT VALUE # 1
40025	SYNC INPUT VALUE # 2
40026	SYNC INPUT VALUE # 3

When the module receives the Synchronism command (refer to "Procedures" section), the input values measured at that moment and contained in the registers 40015 - 40018 are saved, in order of channel, into these registers.

Introduces an offset to the input value of each channel. The value is expressed in the same format as the input registers.

Register	Type
40039	REAL ZERO OF INPUT #0
40040	REAL SPAN OF INPUT #0
40041	SCALED PHYSICAL ZERO #0
40042	SCALED PHYSICAL SPAN #0
40043	REAL ZERO OF INPUT #1
40044	REAL SPAN OF INPUT #1
40045	SCALED PHYSICAL ZERO #1
40046	SCALED PHYSICAL SPAN #1
40047	REAL ZERO OF INPUT #2
40048	REAL SPAN OF INPUT #2
40049	SCALED PHYSICAL ZERO #2
40050	SCALED PHYSICAL SPAN #2
40051	REAL ZERO OF INPUT #3
40052	REAL SPAN OF INPUT #3
40053	SCALED PHYSICAL ZERO #3
40054	SCALED PHYSICAL SPAN #3

Set the scaling, if desired, of the input registers (40015 - 40018) into the associated physical parameters.

The scaling allows the association of the configured input values and the actual physical parameters to which the input is referring to (for example, voltage associates mV to litres).

Set the range of the sensor value measured by the module (for example for Voltage 0 and 50 mV) in the fields "Real Zero of Input" (minimum value of the input scale) and "Real Span of input" (maximum value of the input scale) associated to each channel, and set the range of the converted values (for example mm) in the fields "Scaled Physical Zero" (minimum value) and "Scaled Physical Span" (maximum value) associated to each channel.

Example:

To convert a Voltage input 0-50 mV into physical parameters 100-2000 litres, set the parameters as follows:

40039 = 0 40040 = 5000 40041 = 100 40042 = 2000

The following association of values will be made in the input registers that will contain the following values:

0 mV = "10" 25 mV = "1050" 50 mV = "2000"

The default value of these registers is 0 for the parameters of Zero and 1 for the parameters of Span. This is in order to give the actual values of the configured input sensors as measured by the module.

13 Procedures

USE OF "INIT" FUNCTION

The "INIT" function allows the module to be set in the default configuration, independently of the register configuration. To use this function the dip-switches must all be in the OFF position.

The INIT forces: mode RTU, parity NONE, baud rate 9600, number of bits = 8, address 1

- Only connect the module to be configured to the RS485 port.
- Switch-off the module.
- Connect the terminal INIT to the terminal REF.
- Power-on the module.
- Check that the green "PWR" LED on the front of the module is on. If not, check the power supply connection (terminals V+ and V-).
- Set the controller communications port with the following values:
 - Mode = Modbus RTU
 - Baud-rate = 9600 bps
 - Parity = None
 - No. bits = 8
 - Stop bits = 1
- the module will respond to the address 01.
- Write the desired settings to the following Module registers:
 - 40006: "Communication" to set the baud-rate.
 - 40007: "Address" to set the address of the module.
- Switch-off the module.
- Disconnect the terminal INIT from the terminal REF.
- Power-on the module with all the dip-switches in the OFF position.
- Set the controllers communication port with the baud-rate configured in the register 40006.
- The module will respond to the address configured in the register 40007.

NOTE:

The default configuration values are the following:

- Address: 01
- Baud-rate: 38400 bps
- Protocol: RTU
- Parity: None

WATCHDOG

HE379 series modules have a Watchdog timer that, if enabled, activates an alarm each time that the communication exceeds the configured time. In the alarm condition, the green PWR LED on the front starts to blink once per second and this forces the coil "Watchdog Event" to 1. To exit the alarm condition, reset the "Watchdog Event" coil. The LED will stop blinking.

SYNCHRONISM

The function of Synchronism is a broadcast command sent to all the modules on the RS-485 network. When the modules receive this command, all the input values measured on receipt are saved to the appropriate registers. To send the command, write the value 10 into the register "Test" (40001), to the address '255'.

NOTE: the values of synchronism are not saved in EEPROM. After each power-on the values in the registers are reset.

CONFIGURATION BY DIP SWITCHES

Note: Set all the dip-switches to the OFF position to access the module in EEPROM mode (the module will follow the configuration parameters set by the registers) and INIT mode.

To program the module using the dip-switches, the module must be reset.

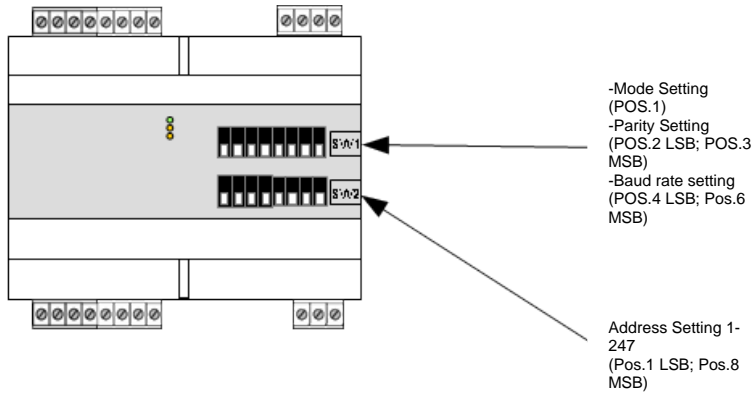

Note (*)

- in **Modbus RTU** mode the setting is **NONE, number of bits = 8**
- in **Modbus ASCII** mode the setting is **MARK, number of bits = 7**
- For the table of configuration refer to **TAB 4. Address Selection** (below).

DIP POSITION



14 Installation / safety

Warning: Remove power from the OCS controller, CAN port, and any peripheral equipment connected to this local system before adding or replacing this or any module.

- All applicable codes and standards should be followed in the installation of this product.
- Shielded, twisted-pair wiring should be used for best performance.
- Shields may be terminated at the module terminal strip.
- In severe applications, shields should be tied directly to the ground block within the panel.
- Use the following wire type or equivalent: Belden 8441.

For detailed installation and a handy checklist that covers panel box layout requirements and minimum clearances, refer to the hardware manual of the controller you are using.

When found on the product, the following symbols specify:



15 Technical support

Technical Support at the following locations:

North America:

Tel: 317 916-4274
 Fax: 317 639-4279
 Web: www.hornerautomation.com
 Email: techsppt@heapg.com

Europe:

Tel: +353-21-4321266
 Fax: +353-21-4321826
 Web: <http://www.horner-apg.com>
 Email: tech.support@horner-apg.com

No part of this publication may be reproduced without the prior agreement and written permission of Horner APG, Inc. Information in this document is subject to change without notice.

TAB.4 Address Selection 1 - 247 (Pos.1 LSB; Pos.8 MSB)

SW2	1 2 3 4 5 6 7 8	1 2 3 4 5 6 7 8	1 2 3 4 5 6 7 8	1 2 3 4 5 6 7 8	1 2 3 4 5 6 7 8	1 2 3 4 5 6 7 8	1 2 3 4 5 6 7 8
	EEPROM	Address 38	Address 76	Address 114	Address 152	Address 190	Address 228
	Address 1	Address 39	Address 77	Address 115	Address 153	Address 191	Address 229
	Address 2	Address 40	Address 78	Address 116	Address 154	Address 192	Address 230
	Address 3	Address 41	Address 79	Address 117	Address 155	Address 193	Address 231
	Address 4	Address 42	Address 80	Address 118	Address 156	Address 194	Address 232
	Address 5	Address 43	Address 81	Address 119	Address 157	Address 195	Address 233
	Address 6	Address 44	Address 82	Address 120	Address 158	Address 196	Address 234
	Address 7	Address 45	Address 83	Address 121	Address 159	Address 197	Address 235
	Address 8	Address 46	Address 84	Address 122	Address 160	Address 198	Address 236
	Address 9	Address 47	Address 85	Address 123	Address 161	Address 199	Address 237
	Address 10	Address 48	Address 86	Address 124	Address 162	Address 200	Address 238
	Address 11	Address 49	Address 87	Address 125	Address 163	Address 201	Address 239
	Address 12	Address 50	Address 88	Address 126	Address 164	Address 202	Address 240
	Address 13	Address 51	Address 89	Address 127	Address 165	Address 203	Address 241
	Address 14	Address 52	Address 90	Address 128	Address 166	Address 204	Address 242
	Address 15	Address 53	Address 91	Address 129	Address 167	Address 205	Address 243
	Address 16	Address 54	Address 92	Address 130	Address 168	Address 206	Address 244
	Address 17	Address 55	Address 93	Address 131	Address 169	Address 207	Address 245
	Address 18	Address 56	Address 94	Address 132	Address 170	Address 208	Address 246
	Address 19	Address 57	Address 95	Address 133	Address 171	Address 209	Address 247
	Address 20	Address 58	Address 96	Address 134	Address 172	Address 210	
	Address 21	Address 59	Address 97	Address 135	Address 173	Address 211	
	Address 22	Address 60	Address 98	Address 136	Address 174	Address 212	
	Address 23	Address 61	Address 99	Address 137	Address 175	Address 213	
	Address 24	Address 62	Address 100	Address 138	Address 176	Address 214	
	Address 25	Address 63	Address 101	Address 139	Address 177	Address 215	
	Address 26	Address 64	Address 102	Address 140	Address 178	Address 216	
	Address 27	Address 65	Address 103	Address 141	Address 179	Address 217	
	Address 28	Address 66	Address 104	Address 142	Address 180	Address 218	
	Address 29	Address 67	Address 105	Address 143	Address 181	Address 219	
	Address 30	Address 68	Address 106	Address 144	Address 182	Address 220	
	Address 31	Address 69	Address 107	Address 145	Address 183	Address 221	
	Address 32	Address 70	Address 108	Address 146	Address 184	Address 222	
	Address 33	Address 71	Address 109	Address 147	Address 185	Address 223	
	Address 34	Address 72	Address 110	Address 148	Address 186	Address 224	
	Address 35	Address 73	Address 111	Address 149	Address 187	Address 225	
	Address 36	Address 74	Address 112	Address 150	Address 188	Address 226	
	Address 37	Address 75	Address 113	Address 151	Address 189	Address 227	